



**WATERSTAGE™**



Ecolabel (35°C / 55°C)		<b>A++ / A+</b>		Ecolabel (35°C / 55°C)	
Binnenunit	Type	<b>WC13</b>		Type	Unité intérieure
	Fabriekscod	WSHG140DG		Code de fabrication	
Buitenunit	Type	<b>WOC13RIYF</b>		Type	Unité extérieure
	Fabriekscod	WOHK112LCTA		Code de fabrication	
Koelmiddel		R410A			Réfrigérant
Verwarming (*)	Vermogen +7°C/35°C	kW	10,8	kW	Puissance +7°C/35°C
	Opgeen. elektr. vermogen	kW	2,51	kW	Puissance él. absorbée
	COP		4,30		COP
	Vermogen +2°C/35°C	kW	4,97	kW	Puissance +2°C/35°C
	Opgeen. elektr. vermogen	kW	1,28		Puissance él. absorbée
	COP		3,87		COP
	Vermogen +7°C/45°C	kW	10,10		Puissance +7°C/45°C
	Opgeen. elektr. vermogen	kW	3,01	kW	Puissance él. absorbée
	COP		3,36		COP
	Vloestof injectie		Ja/Oui		Injection liquide
Verwarming Max. vermogen	Vermogen -10°C/35°C	kW	10,80	kW	Puissance-10°C/35°C
	Vermogen -10°C/45°C	kW	10,02	kW	Puissance-10°C/45°C
	Vermogen -10°C/60°C	kW	-	kW	Puissance-10°C/60°C
	Vermogen -15°C/35°C	kW	10,80	kW	Puissance-15°C/35°C
	Vermogen -15°C/45°C	kW	10,02	kW	Puissance-15°C/45°C
	Vermogen -15°C/60°C	kW	-	kW	Puissance-15°C/60°C
Koeling			optie/option		Refroidissement
Binnendeel	Waterdebiet nominaal	l/u	1891	l/h	Débit d'eau nominal
	Waterdebiet minimaal	l/u	1200	l/h	Débit d'eau minimal
	Werkdruk maximaal	Bar	3	Bar	Pression opérationnelle max.
	Wateruitrede min-max	°C	+8/+55	°C	Sortie d'eau min./max.
	Waterinhoud	L	16	L	Contenu eau
	Expansievat	L	8	L	Vase d'expansion
	Hoogte-breedte-lengte	mm	800-450-457	mm	Hauteur-largeur-profondeur
	Gewicht (leeg-gevuld)	kg	42-58	kg	Poids (vide-plein)
Kleur (benadering)	RAL	9003	RAL	Couleur (approximative)	
Buitendeel	Geluidsniveau	dB(A)	51	dB(A)	Niveau sonore
	Debiet (hoog)	m³/h	6200	m³/h	Débit (haut)
	Compressor		Twin Rotary LI		Compresseur
	Werkingslim. verwarmen	°C	-25/+35	°C	Plage de fonct. chauff.
	Hoogte-breedte-lengte	mm	1290-900-330	mm	Hauteur/largeur/profond.
	Gewicht	kg	99	kg	Poids
	Kleur	RAL	1013	RAL	Couleur
Elektr. install.	Voeding	V	400V/3F+N	V	Alimentation
	Stroom max. verwarmen	A	9	A	Amp. max chauffage
	Zekering traag	A	16	A	Fusible retardé
	Hoofdvoeding aanbr.op		buiten/ext.		Unité à alimenter
	Sectie voedingskabel	mm²	5G2,5	mm²	Section câble alimentation
	Sectie tssn bi en bu	mm²	4G1,5	mm²	Section entre int. et ext.
	Voeding SWW	V	230/1	V	Alimentation ECS
Zekering SWW	A	16	A	Fusible chauffage ECS	
	Sectie verwarming SWW	mm²	3G2,5	mm²	Section chauffage ECS
Tech. install.	Hydr. aansluiting binnendeel	inch	2x1"	inch	Raccordement hydraulique
	Diameter hoofdleiding	inch	5/4"	inch	Diamètre tuyau principal
	Expansie		buiten/ext.		Détente
	Zuigleiding bi/bu	inch	5/8	inch	Diamètre gaz int/ext
	Vloeistofleiding bi/bu	inch	3/8	inch	Diamètre liquide int/ext
	Standaardvulling (CO <sub>2</sub> -eq)**	kg-m (kg)	2,5-15 (5220)	kg-m (kg)	Charge standard (CO <sub>2</sub> -eq)**
	Bijvulling (CO <sub>2</sub> -eq)**	g/m (kg)	50 (104)	g/m (kg)	Charge supplémentaire (CO <sub>2</sub> -eq)**
	Min./Max. leidinglengte	m	5-20	m	Longueur min./max. tuyaux
	Hoogteverschil max	m	15	m	Dénivelé max
	Diam. condensafvoer bi/bu	mm	32/16	mm	Diam. évac. condensat bi/bu

(\*) gegevens volgens de norm EN14511

(\*\*) Gerekend met een GWP-waarde van 2088 voor R410a

(\*) suivant la norme EN14511

(\*\*) Calculé avec une GWP-valeur de 2088 pour R410a

Binnendeel

Unité intérieure

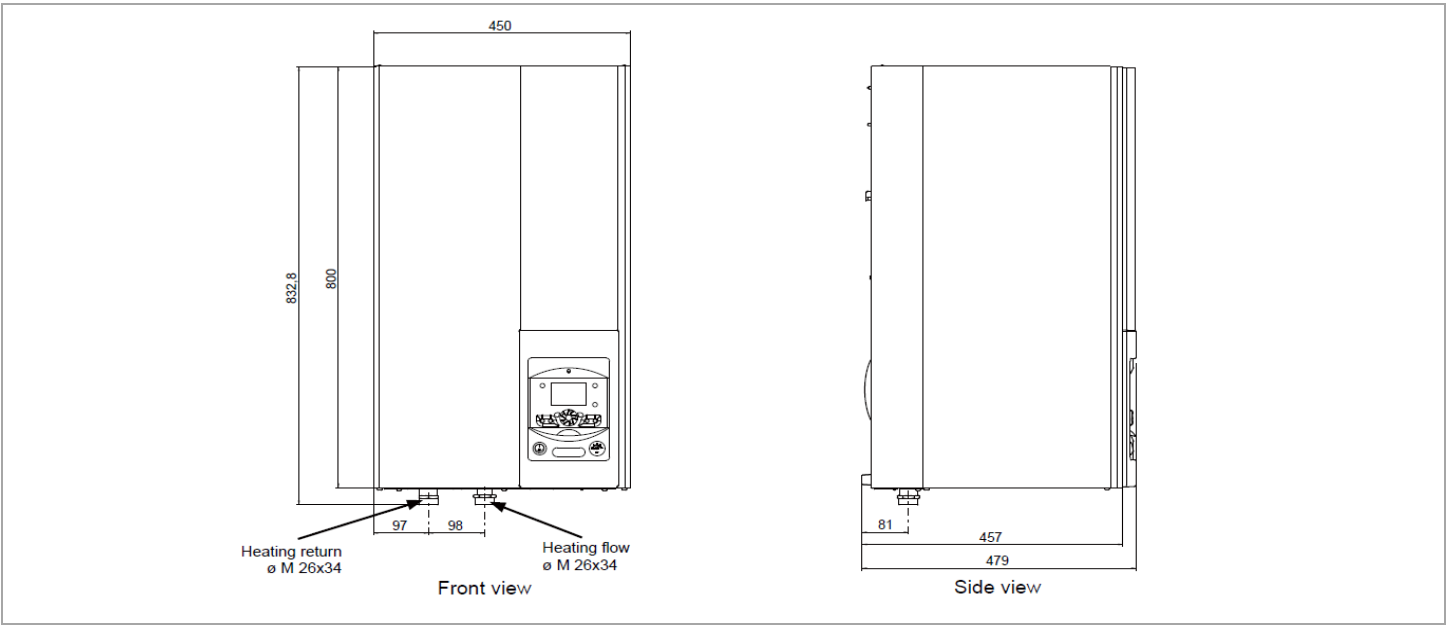

Buitendeel

Unité extérieure

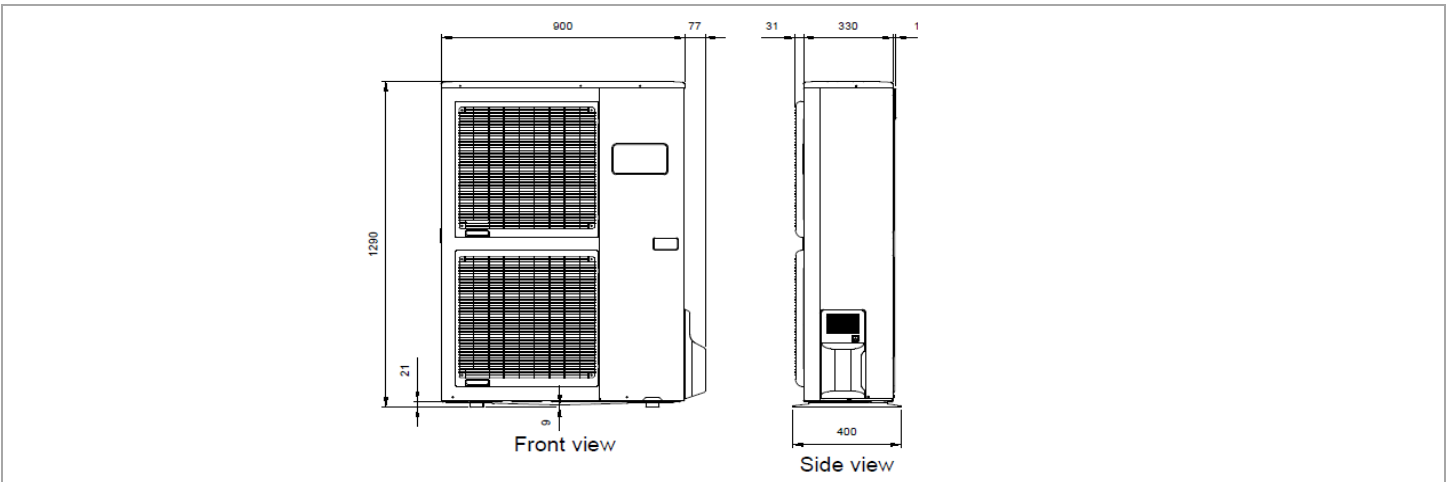

Montage



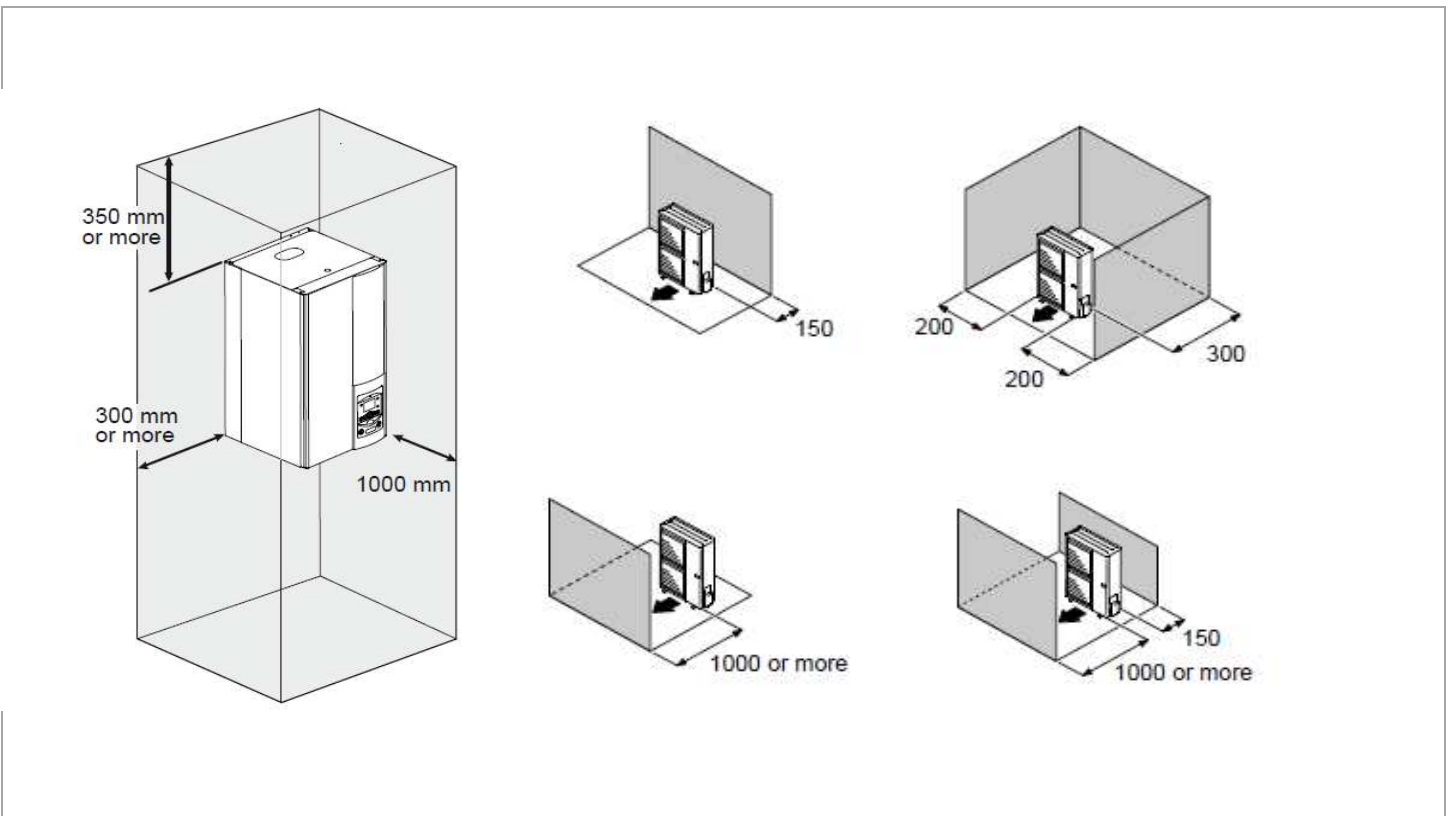

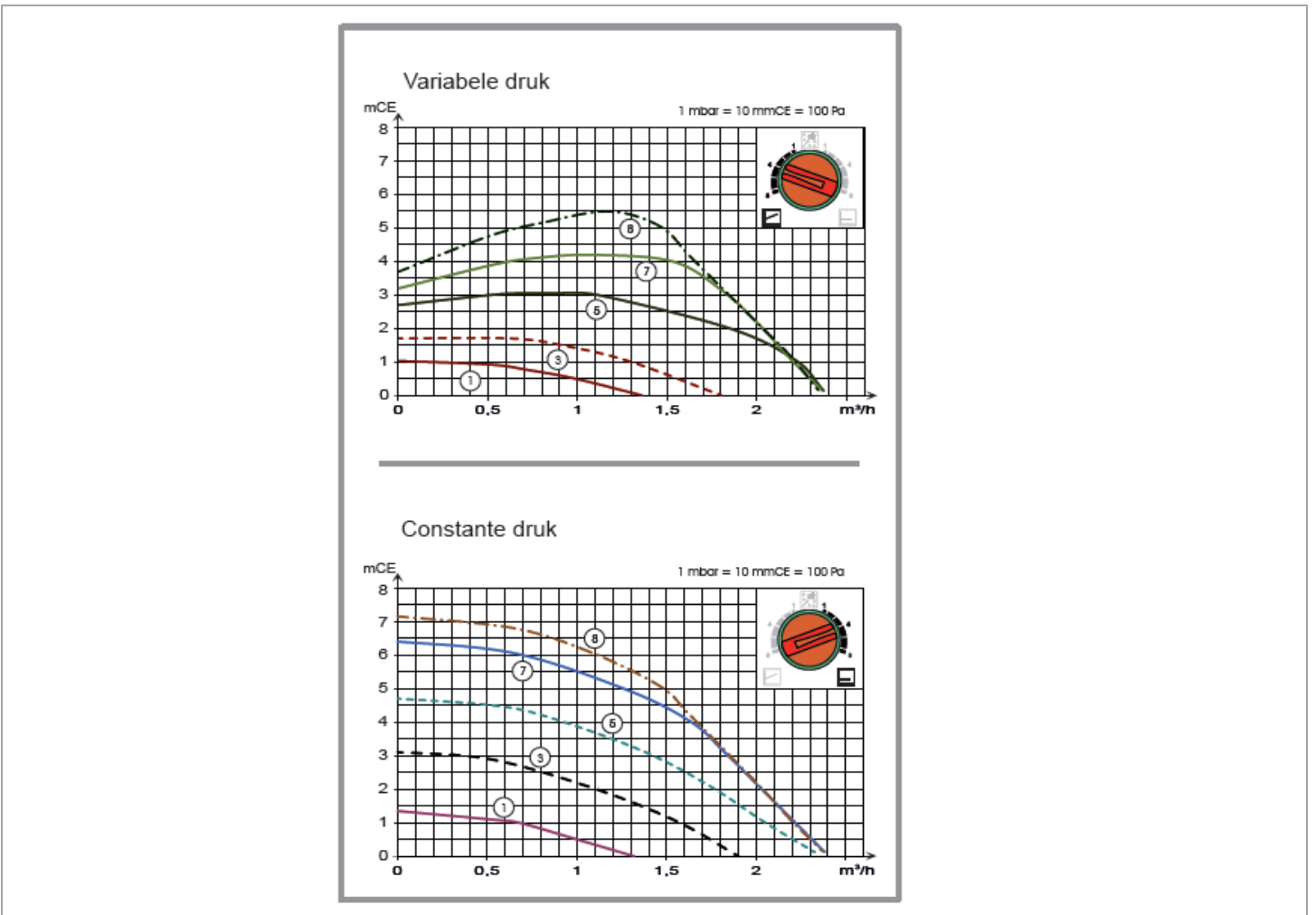
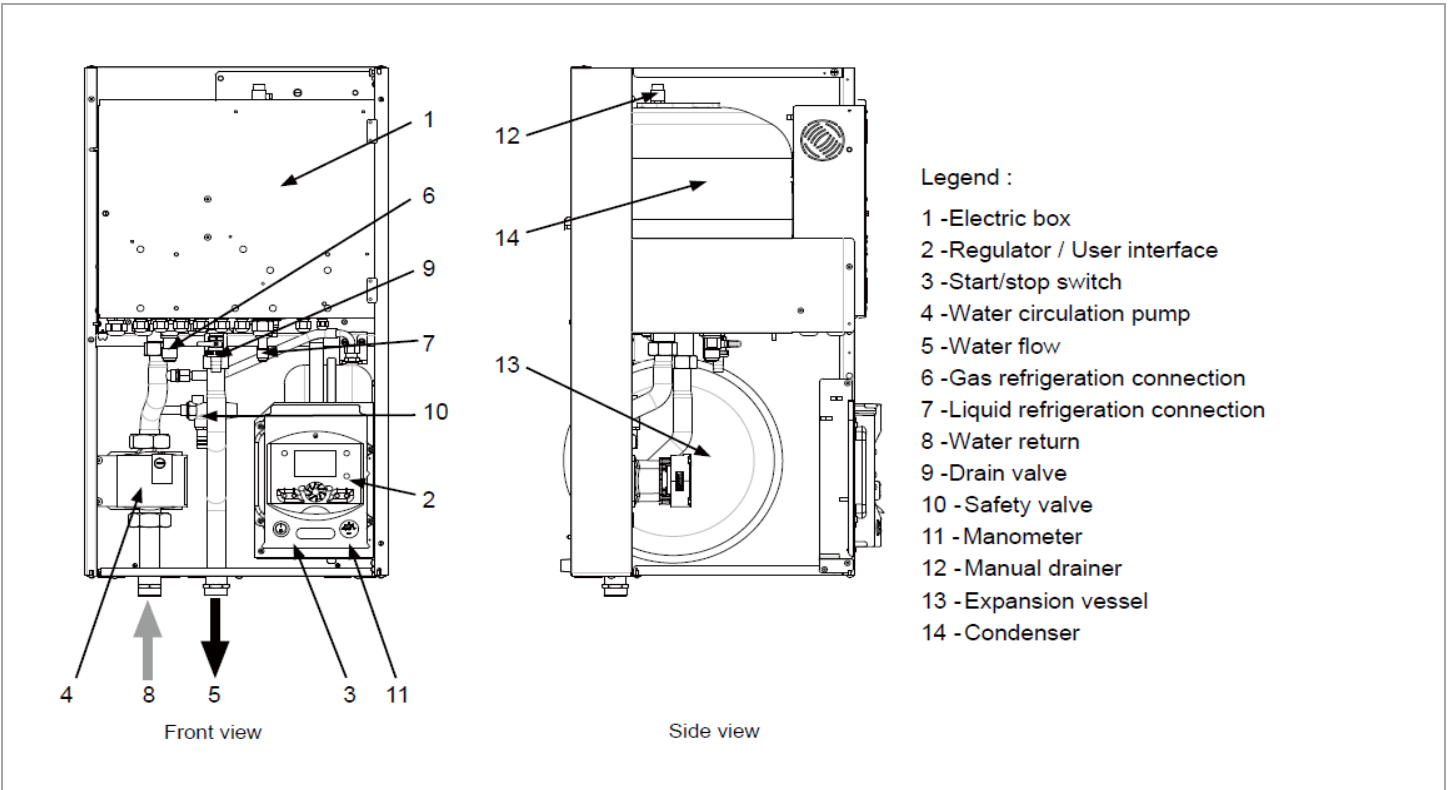

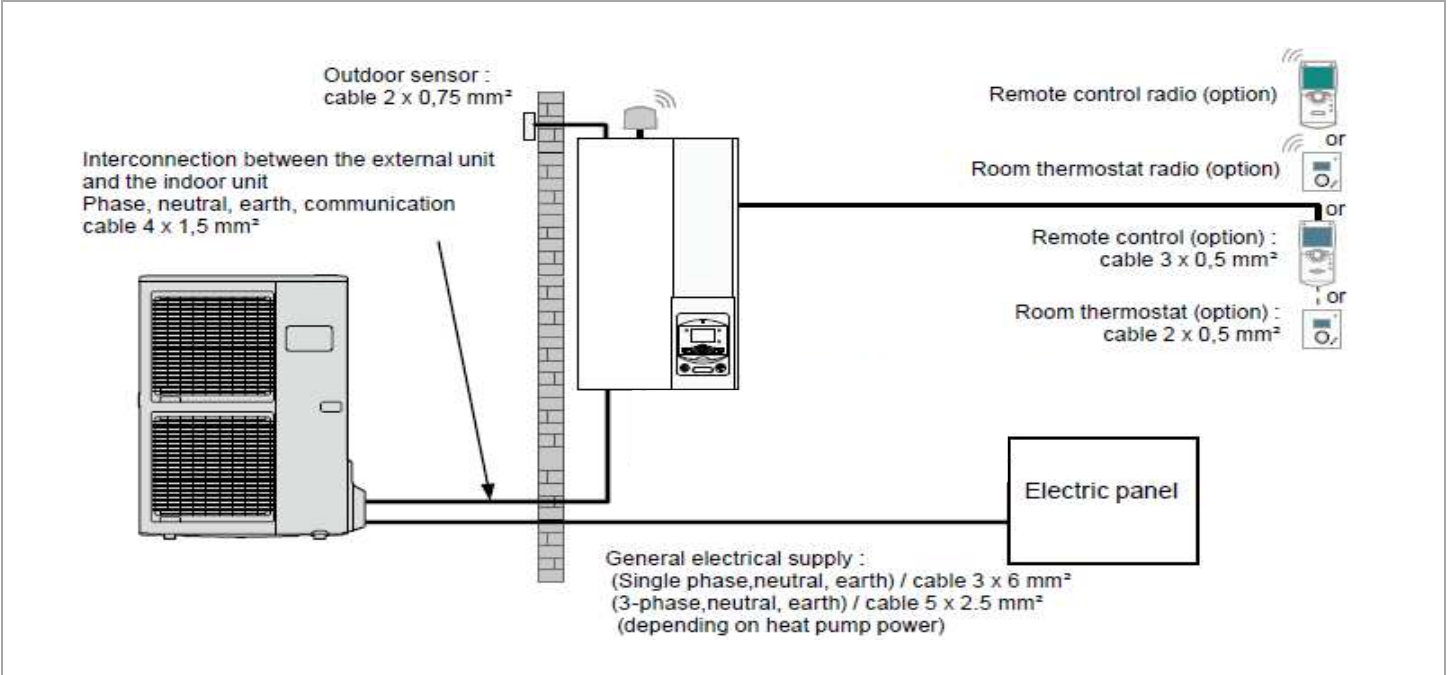
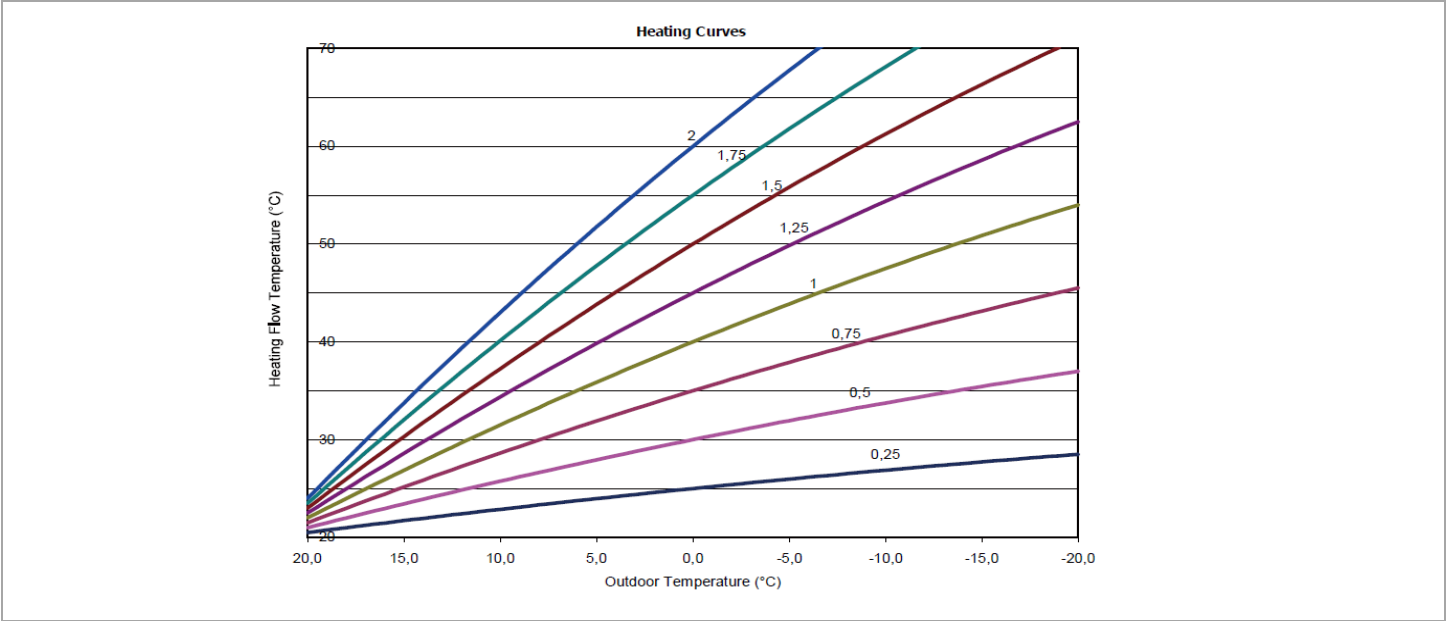

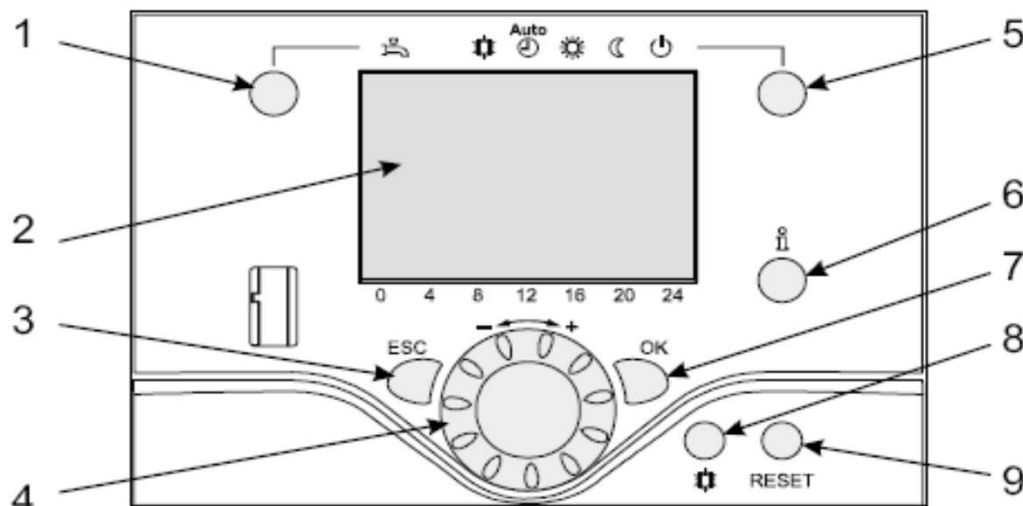

Montage









Ref.	Function	- Definitions
1	Selection of the DHW operating regime (Domestic hot water)	<ul style="list-style-type: none"> <li>- If the installation is fitted with a DHW tank.</li> <li>- ON: Production of DHW according to the time program.</li> <li>- Off: Preparing the domestic hot water for stopping with the anti-frost function active.</li> <li>- Boost: Hold down the DHW key for 3 seconds. Immediate DHW operation after use of the electrical back-ups until the DHW comfort setting has been reached</li> </ul>
	 ON	
	 Off	
2	Digital display	<ul style="list-style-type: none"> <li>- Operating control. Readout of the current temperature, of the heating regime and of any faults  .</li> <li>- View the settings</li> </ul>
3	Exit "ESC"	- Quit the menu.
4	Navigation and setting	<ul style="list-style-type: none"> <li>- Selecting the menu.</li> <li>- Setting parameters.</li> <li>- Adjusting the ambient temperature setpoint.</li> </ul>
5	Selecting the heating regime	<ul style="list-style-type: none"> <li>-  Heating operating according to the heating programme (Summer/winter mode switchover is automatic).</li> <li>-  Constant comfort temperature.</li> <li>-  Constant reduced temperature.</li> <li>-  Stand-by regime with anti-frost protection (Provided that the heat pump's electrical power supply is not interrupted).</li> </ul>
6	Information display	<ul style="list-style-type: none"> <li>- Various data (please see page 59).</li> <li>-  Reading error codes (please see page 57).</li> <li>-  Information concerning maintenance, special regime.</li> </ul>
7	Confirm "OK"	<ul style="list-style-type: none"> <li>- Input into the selected menu.</li> <li>- Confirmation of the parameter settings.</li> <li>- Confirmation of the adjustment to the comfort temp. setting.</li> </ul>
8	Selecting cooling mode	<ul style="list-style-type: none"> <li>- If the installation is fitted with the cooling kit:</li> <li>-  Cooling operating according to the heating programme (Summer/winter mode switchover is automatic).</li> </ul>
9	RESET button (Hold down the "RESET" key for 3 seconds).	<ul style="list-style-type: none"> <li>- Reinitialising the parameters and cancelling error messages. Do not use during normal operation.</li> </ul>

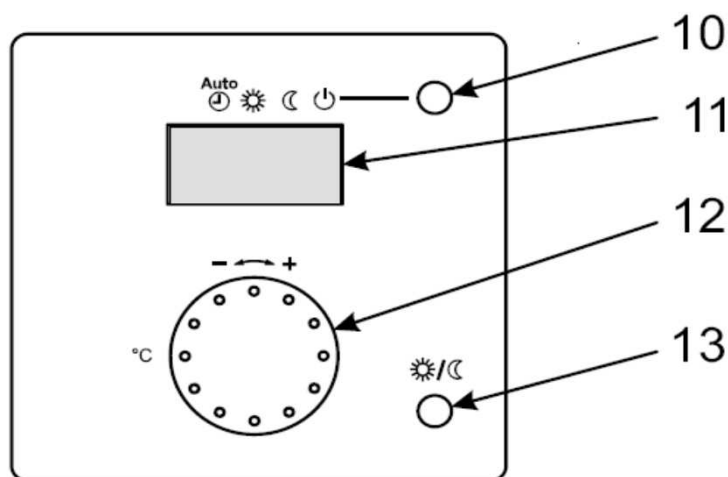

Ref.	Function	- Definitions
10	Selecting the heating regime	<ul style="list-style-type: none"> <li>-  Heating operating according to the heating programme (Summer/winter mode switchover is automatic).</li> <li>-  Constant comfort temperature.</li> <li>-  Constant reduced temperature.</li> <li>-  Stand-by regime with anti-frost protection (Provided that the heat pump's electrical power supply is not interrupted).</li> </ul>
11	Digital display	- Operating control. Readout of the current temperature, of the heating regime and of any faults  .
12	Control knob	- Adjusting the ambient temperature setpoint
13	Presence key	- Comfort / Reduced switchover