





Ecolabel (35°C / 55°C)			A++ / A+		Ecolabel (35°C / 55°C)		
Binnenunit	Type		WC13		Type		Unité intérieure
	Fabriekscode		WSHG140DG		Code de fabrication		
Buitenunit	Type		WOC13RIY		Type		Unité extérieure
	Fabriekscode		WOHG112LHT		Code de fabrication		
Koelmiddel			R410A				Réfrigérant
Verwarming (*)	Vermogen +7°C/35°C	kW	10,8	kW	Puissance +7°C/35°C		Chauffage (*)
	Opgen. elektr. vermogen	kW	2,54	kW	Puissance él. absorbée		
	COP		4,25		COP		
	Vermogen +2°C/35°C	kW	4,97	kW	Puissance +2°C/35°C		
	Opgen. elektr. vermogen	kW	1,33		Puissance él. absorbée		
	COP		3,73		COP		
	Vermogen +7°C/45°C	kW	9,23		Puissance +7°C/45°C		
	Opgen. elektr. vermogen	kW	2,84	kW	Puissance él. absorbée		
	COP		3,25		COP		
	Vloeistof injectie		Ja/Oui		Injection liquide		
Verwarming Max. vermogen	Vermogen -10°C/35°C	kW	10,80	kW	Puissance -10°C/35°C		Chauffage Puissance max.
	Vermogen -10°C/45°C	kW	9,16	kW	Puissance -10°C/45°C		
	Vermogen -10°C/60°C	kW	-	kW	Puissance -10°C/60°C		
	Vermogen -15°C/35°C	kW	10,80	kW	Puissance -15°C/35°C		
	Vermogen -15°C/45°C	kW	9,16	kW	Puissance -15°C/45°C		
	Vermogen -15°C/60°C	kW	-	kW	Puissance -15°C/60°C		
Koeling			optie/option				Refroidissement
Binnendeel	Waterdebiet nominaal	l/u	1891	l/h	Débit d'eau nominal		Unité intérieure
	Waterdebiet minimaal	l/u	1200	l/h	Débit d'eau minimal		
	Werkdruk maximaal	Bar	3	Bar	Pression opérationnelle max.		
	Wateruittrede min-max	°C	+8/+55	°C	Sortie d'eau min./max.		
	Waterinhoud	L	16	L	Contenu eau		
	Expansievat	L	8	L	Vase d'expansion		
	Hoogte-breedte-lengte	mm	800-450-457	mm	Hauteur-largeur-profondeur		
	Gewicht (leeg-gevuld)	kg	42-58	kg	Poids (vide-plein)		
Kleur	RAL	9003	RAL	Couleur			
Buitendeel	Geluidsniveau	dB(A)	54	dB(A)	Niveau sonore		Unité extérieure
	Debiet (hoog)	m³/h	6200	m³/h	Débit (haut)		
	Compressor		Twin Rotary LI		Compresseur		
	Werkingslim. verwarmen	°C	-25/+35	°C	Plage de fonct. chauff.		
	Hoogte-breedte-lengte	mm	1290-900-330	mm	Hauteur/largeur/profond.		
	Gewicht	kg	92	kg	Poids		
	Kleur (benadering)	RAL	1013	RAL	Couleur (approximative)		
Elektr. install.	Voeding	V	230/1	V	Alimentation		Install. électr.
	Stroom max. verwarmen	A	22	A	Amp. max chauffage		
	Zekering traag	A	25	A	Fusible retardé		
	Hoofdvoeding aanbr.op		buiten/ext.		Unité à alimenter		
	Sectie voedingskabel	mm²	3G4	mm²	Section câble alimentation		
	Sectie tssn bi en bu	mm²	4G1,5	mm²	Section entre int. et ext.		
	Voeding SWW	V	230/1	V	Alimentation ECS		
	Zekering SWW	A	16	A	Fusible chauffage ECS		
Sectie verwarming SWW	mm²	3G2,5	mm²	Section chauffage ECS			
Tech.install.	Hydr. aansluiting binnendeel	inch	2x1"	inch	Raccordement hydraulique		Install. Techn.
	Diameter hoofdleiding	inch	5/4"	inch	Diamètre tuyau principal		
	Expansie		buiten/ext.		Détente		
	Zuigleiding bi/bu	inch	5/8	inch	Diamètre gaz int/ext		
	Vloeistofleiding bi/bu	inch	3/8	inch	Diamètre liquide int/ext		
	Standaardvulling (CO ₂ -eq)**	kg-m (kg)	2,5-15 (5220)	kg-m (kg)	Charge standard (CO ₂ -eq)**		
	Bijvulling (CO ₂ -eq)**	g/m (kg)	50 (104)	g/m (kg)	Charge supplémentaire (CO ₂ -eq)**		
	Min./Max. leidinglengte	m	5-20	m	Longueur min./max. tuyaux		
	Hoogteverschil max	m	15	m	Dénivelé max		
Diam. condensafvoer bi/bu	mm	32/16	mm	Diam. évac. condensat bi/bu			

(*) gegevens volgens de norm EN14511

(**) Gerekend met een GWP-waarde van 2088 voor R410a

(*) suivant la norme EN14511

(**) Calculé avec une GWP-valeur de 2088 pour R410a

Binnendeel

Unité intérieure

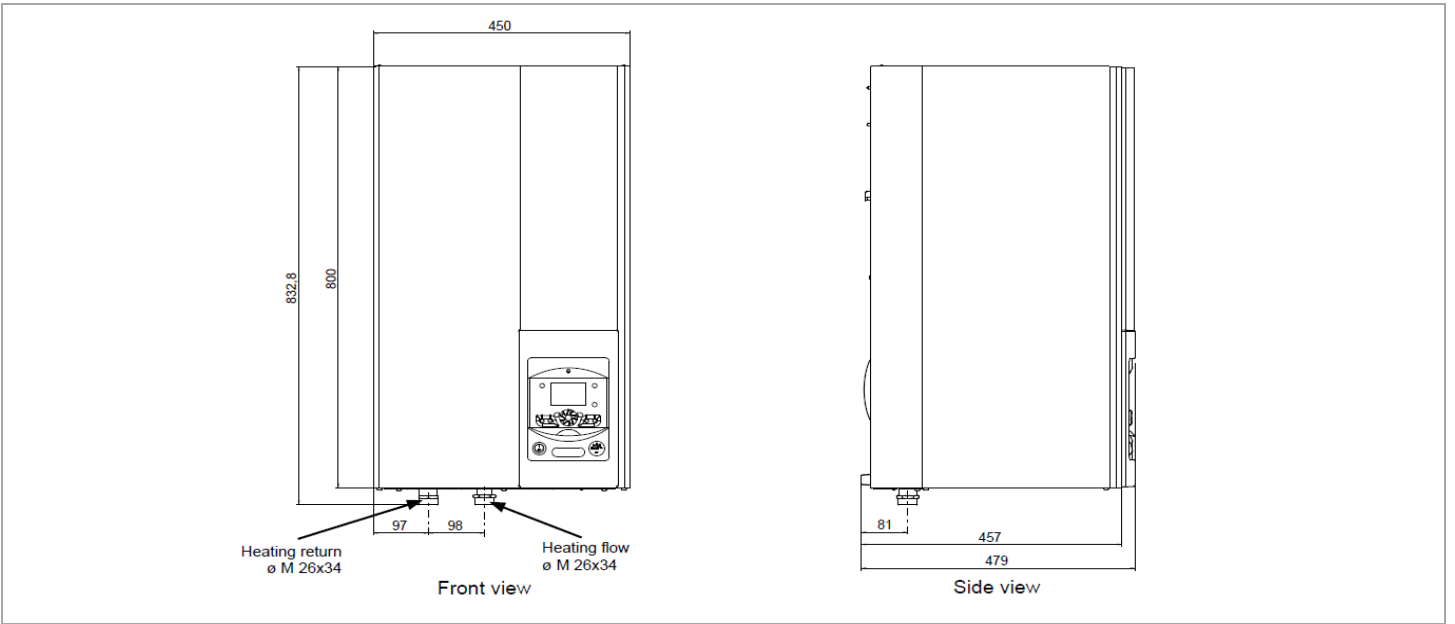

Buitendeel

Unité extérieure

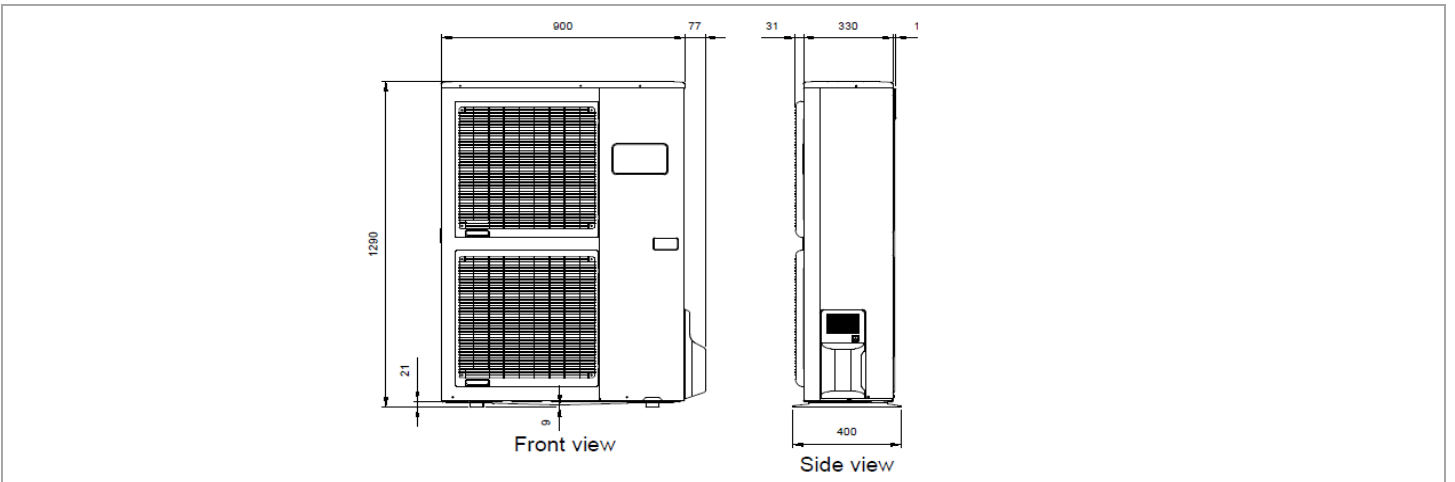

Montage



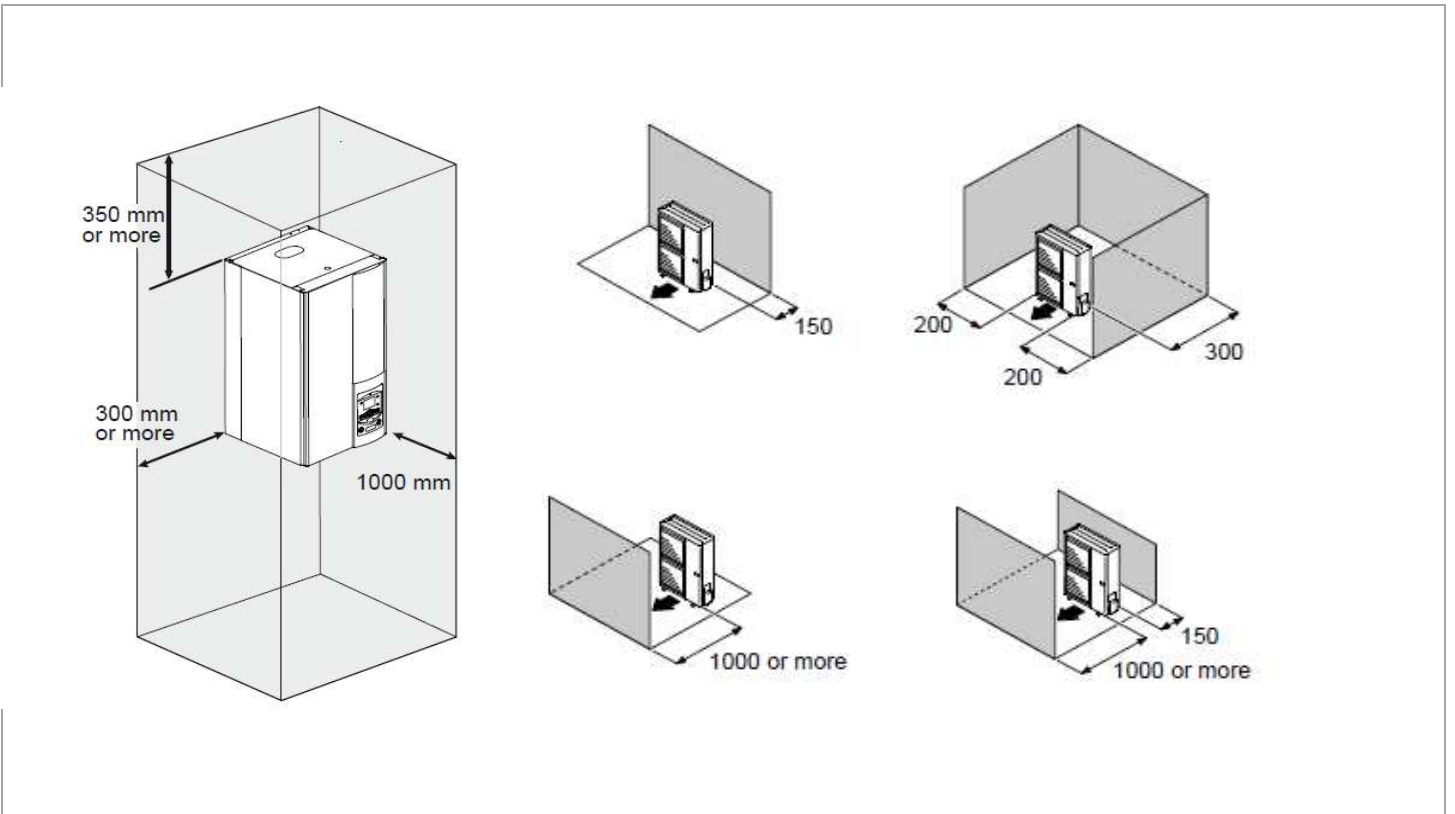

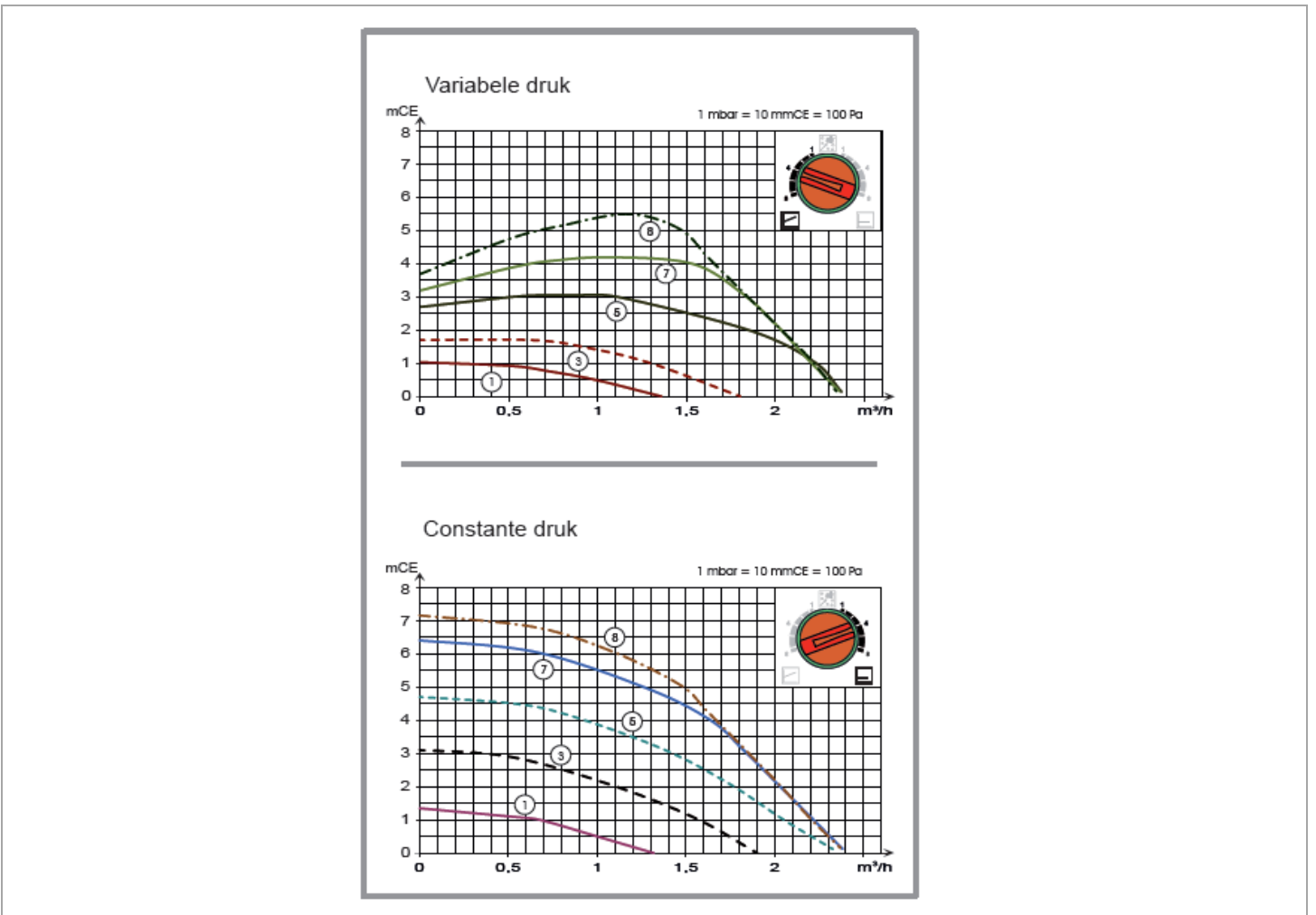
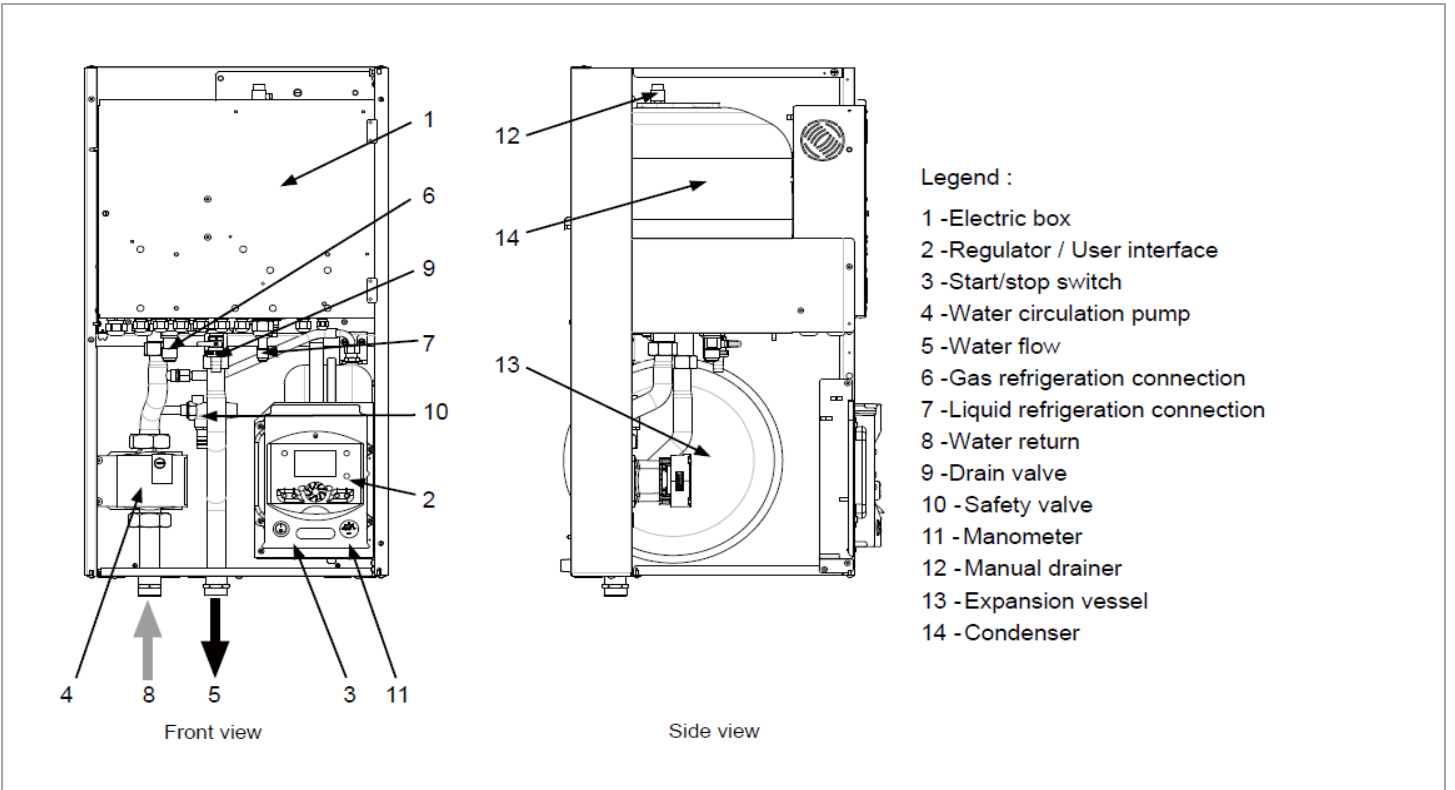

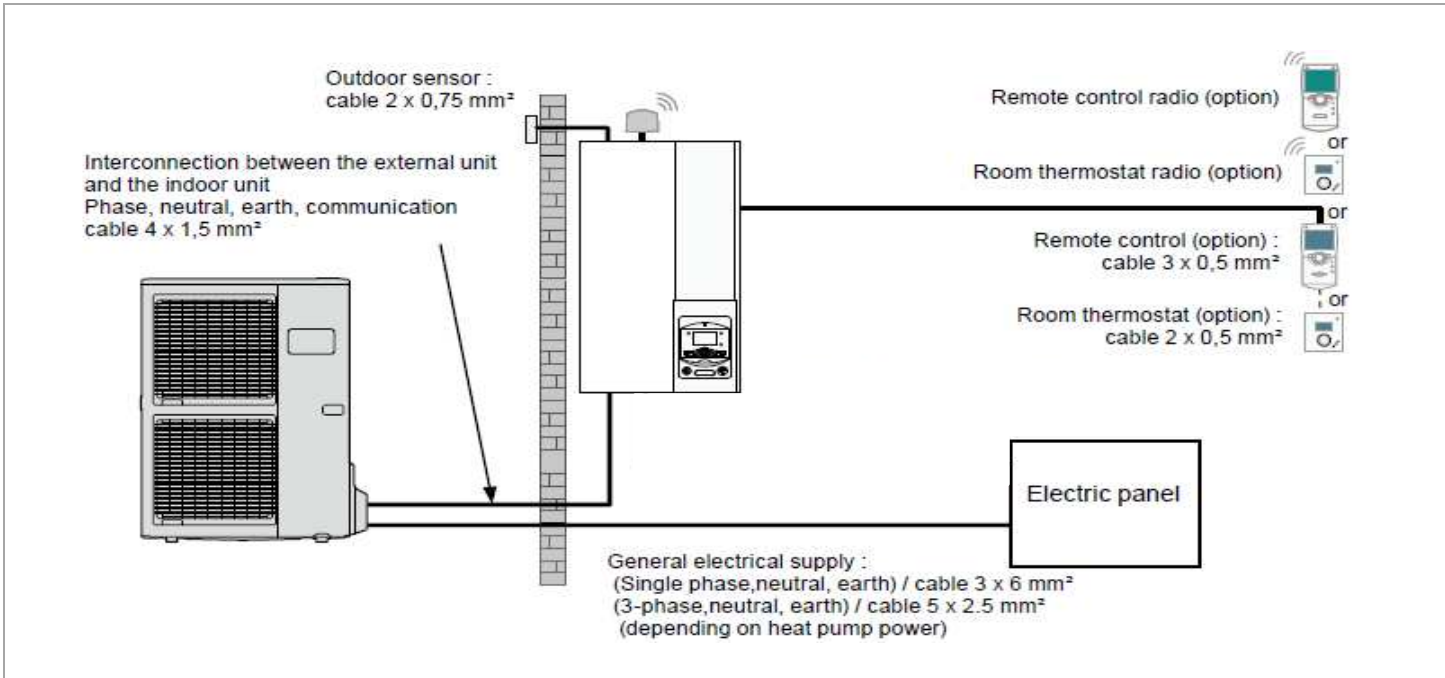
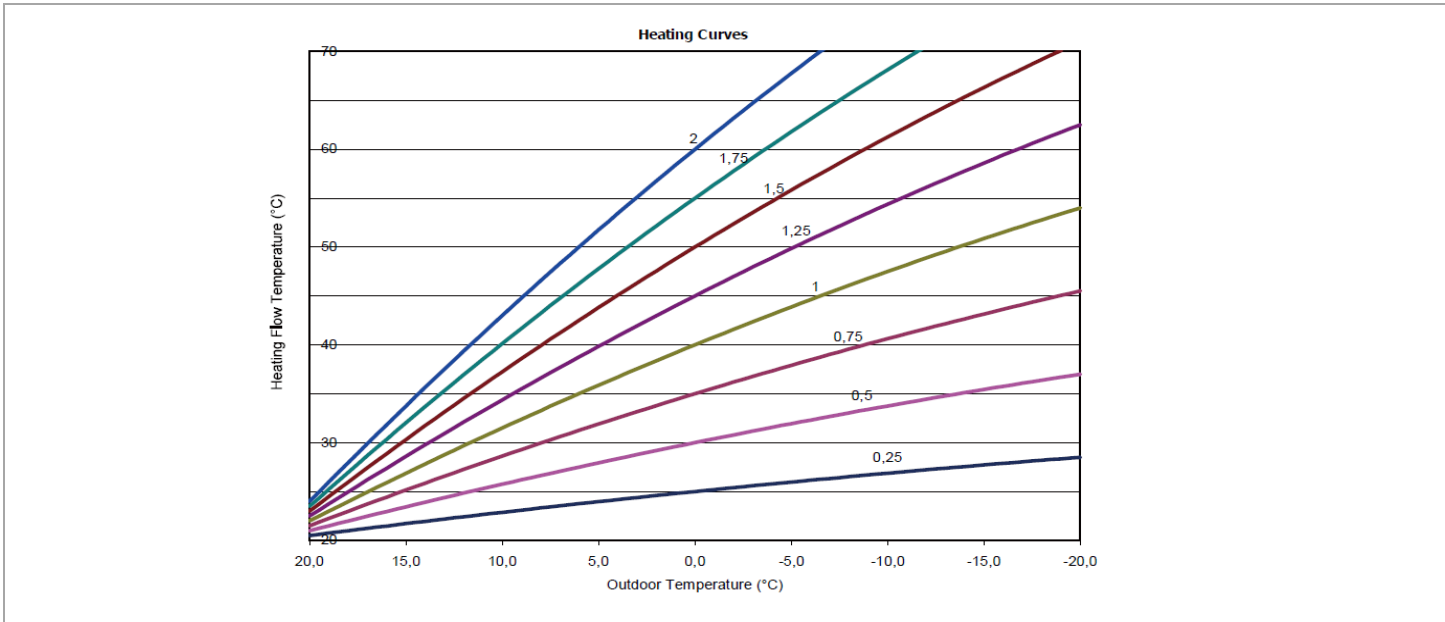

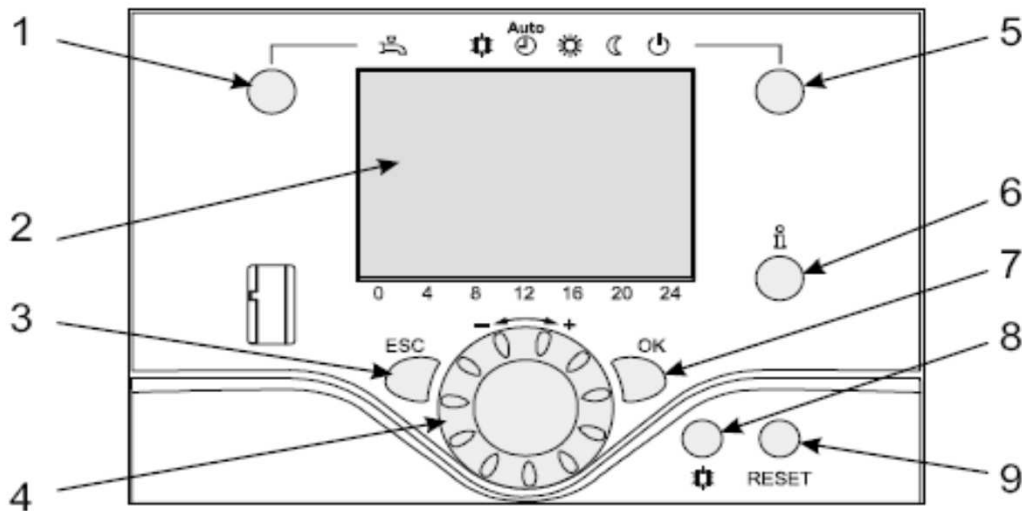
Montage









Ref.	Function	- Definitions
1	Selection of the DHW operating regime (Domestic hot water)	<ul style="list-style-type: none"> - If the installation is fitted with a DHW tank. - ON: Production of DHW according to the time program. - Off: Preparing the domestic hot water for stopping with the anti-frost function active. - Boost: Hold down the DHW key for 3 seconds. Immediate DHW operation after use of the electrical back-ups until the DHW comfort setting has been reached
2	Digital display	<ul style="list-style-type: none"> - Operating control. Readout of the current temperature, of the heating regime and of any faults  . - View the settings
3	Exit "ESC"	- Quit the menu.
4	Navigation and setting	<ul style="list-style-type: none"> - Selecting the menu. - Setting parameters. - Adjusting the ambient temperature setpoint.
5	Selecting the heating regime	<ul style="list-style-type: none"> -  Heating operating according to the heating programme (Summer/winter mode switchover is automatic). -  Constant comfort temperature. -  Constant reduced temperature. -  Stand-by regime with anti-frost protection (Provided that the heat pump's electrical power supply is not interrupted).
6	Information display	<ul style="list-style-type: none"> - Various data (please see page 59). -  Reading error codes (please see page 57). -  Information concerning maintenance, special regime.
7	Confirm "OK"	<ul style="list-style-type: none"> - Input into the selected menu. - Confirmation of the parameter settings. - Confirmation of the adjustment to the comfort temp. setting.
8	Selecting cooling mode	<ul style="list-style-type: none"> - If the installation is fitted with the cooling kit: -  Cooling operating according to the heating programme (Summer/winter mode switchover is automatic).
9	RESET button (Hold down the "RESET" key for 3 seconds).	- Reinitialising the parameters and cancelling error messages. Do not use during normal operation.

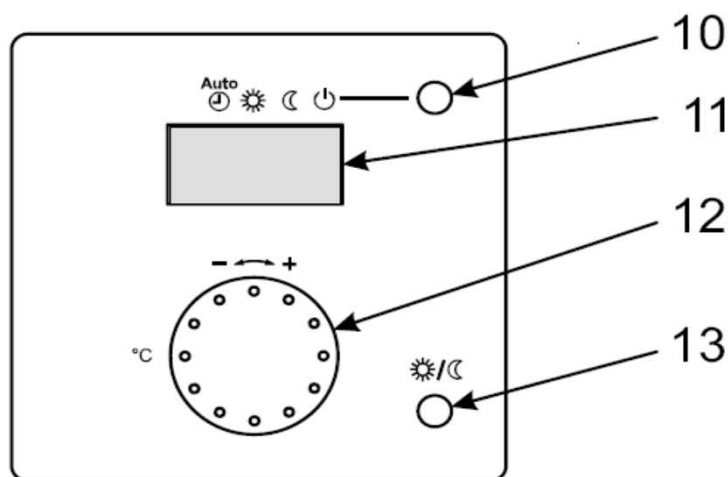

Ref.	Function	- Definitions
10	Selecting the heating regime	<ul style="list-style-type: none"> - Heating operating according to the heating programme (Summer/winter mode switchover is automatic). - Constant comfort temperature. - Constant reduced temperature. - Stand-by regime with anti-frost protection (Provided that the heat pump's electrical power supply is not interrupted).
11	Digital display	- Operating control. Readout of the current temperature, of the heating regime and of any faults .
12	Control knob	- Adjusting the ambient temperature setpoint
13	Presence key	- Comfort / Reduced switchover